

LEDDim Smart

DIGITAL TRAILING EDGE DIMMER



220-240V, 50/60Hz, 3-400VA, -20°C to 35°C, Operating frequency: 2402-2480MHz, Maximum radio-frequency output power: 2dBm

SG Smart

GET IT ON
Google Play

Download on the
App Store

NO: Impulsbryter (valgfritt)
DK: Impulsafbryder (valgfri)
SE: Impulsbrytare (valgfritt)
EN: Push button (optional)
FR: Bouton-poussoir (optionnel)
NL: Drukknop (optioneel)
DE: Druckknopf (optional)
FI: Painonappi (valinnainen)

⌚ 0-1s

⌚ >1s

⚠ L P
Max 50m

NO: Minimum dimmenivåjustering
DA: Minimum justering af dæmpningsniveau
SE: Minsta justering av dimmningsnivå
EN: Minimum dimming level adjustment
FR: Réglage du niveau de gradation minimal
NL: Regelbaar niveau van minimale dimmingsgraad
DE: Anpassung der minimalen Dimmstufe
FI: Minimi himmennystaso

E.g. ELKO

Reset

⌚ 1 ~1 sec.
2

NORWAY
SG Armaturen AS

Skytterheia 25
N-4790 Lillesand

Tel: +47 37 50 03 00
firmapost@sg-as.no
www.sg-as.no

SWEDEN

SG Armaturen AB
Tel: +46 31 81 71 10
info@sg-ab.se
www.sg-ab.se

FINLAND

SG Armaturen Oy
Tel: +358 02 07 30 39 60
info@sg-oy.fi
www.sg-oy.fi

DENMARK

SG Armaturen A/S
Tel: +45 70 70 72 13
info@sg-as.dk
www.sg-as.dk

UNITED KINGDOM

SG Lighting LTD
Tel: +47 37 50 03 00
info@sglighting.co.uk
www.sglighting.co.uk

FRANCE

SG Lighting SA/NV
Tel: +33(0) 4 94 93 00 00
info.france@sglighting.fr
www.sglighting.net

BENELUX

SG Lighting SA/NV
Tel: +32(0) 15 20 72 71
info.benelux@sglighting.net
www.sglighting.net

GERMANY





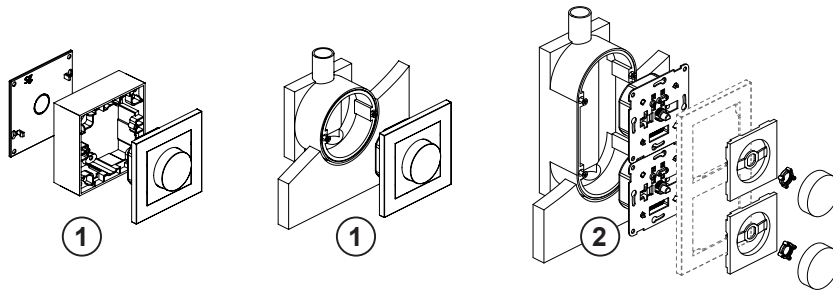

SG Leuchten GmbH
Tel: +49 40 23 99 44 59
info@sg-leuchten.de
www.sg-leuchten.de

INTERNATIONAL

SG Lighting Co Ltd.
Tel: +86 769 88 49 20 88
cindy@sgdgc.com
www.sg-as.com

** Max. load



Load type	 R	 C	 R+C	 L
1 Single dimmer	Max. 400W	Max. 320W	Max. 320W	
2 Two or more dimmers	Max. 300W/pc.	Max. 240W/pc.	Max. 240W/pc.	

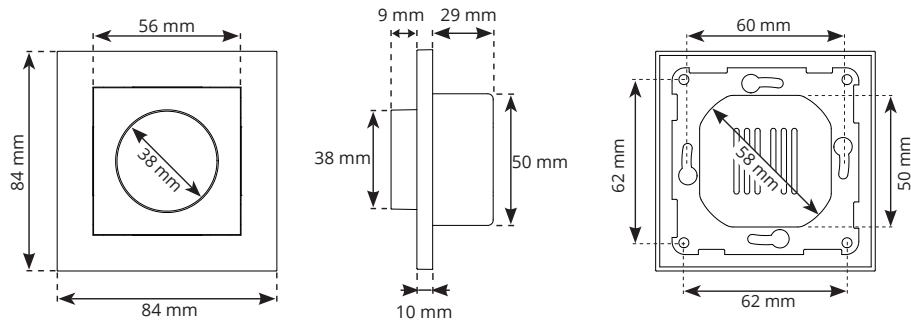
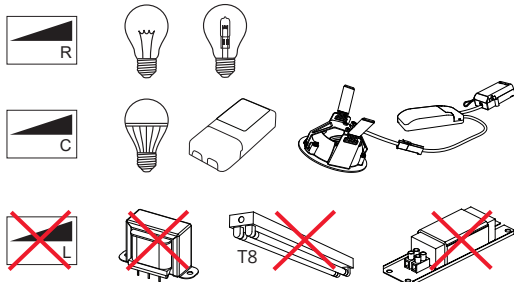

NO: Kan kun installeres og vedlikeholdes av en registrert installasjonsvirksomhet.

DK: Må kun installeres og vedligeholdes af uddannet elektriker.

SE: Skall installeras och underhållas av behörig elektriker.

EN: Only to be installed and maintained by an authorized electrician.

FR: Doit être installé et maintenu par un électricien qualifié.

NL: Mag alleen geïnstalleerd en onderhouden worden door een bevoegde elektricien.

DE: Dieses Produkt darf nur durch autorisiertes Personal (z.B. Elektro-Installateur) angeschlossen, in Betrieb genommen und gewartet werden.

FI: Asentaa ja huoltaa saa vain valtuutettu sähköasentaja

NO: Skru av strømmen før montering.

DK: Sluk for strømmen inden montering.

SE: Stäng av strømmen innan montering.

EN: Turn off power before installing.

FR: Couper le courant avant l'installation.

NL: Stroom uitschakelen voor u het toestel installeert.

DE: Vor Installationsarbeiten den Strom abschalten.

FI: Sammuta virta ennen kytkemistä

Pairing

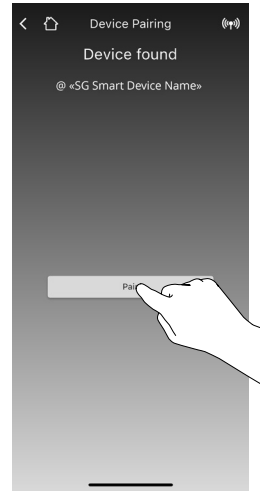
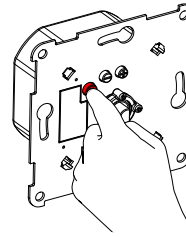
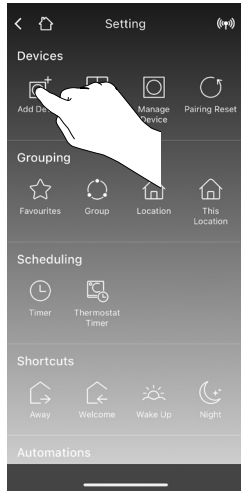

Settings

